

- High Quality blind incorporating a 32mm fluted aluminium roller and a 16mm round bottom rail
- Can be fitted using top, face or side fix brackets
- Large range of fabrics to suit different applications
- All flame retardant to BS5867 Pt2b minimum
- Over sized rollers available up to 5mtr wide modules or multiconnected for wider requirements
- Various operation options including - chain, crank, side winder, spring assisted, electric or remote
- All individually measured and manufactured at our own premises to a high level of standard
- Range of different fabric properties including – Dim out, Black out, Reflective Backed etc.
- Ultra Fresh Coating = Antibacterial and Antifungal properties – kills germs including MRSA and inhibits growth of mold and mildew

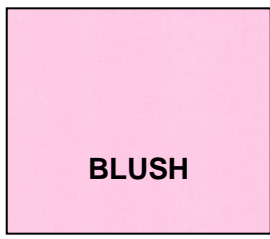

**CONTACT US TODAY
FOR A FREE SITE SURVEY & QUOTATION**

0800 3 10 10 20



BLUSH

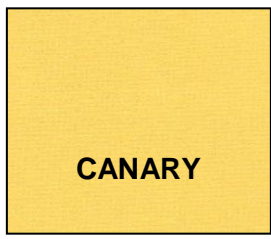

CANARY

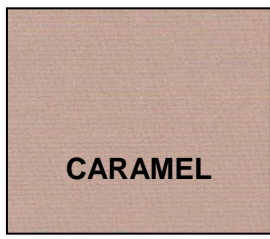

CARAMEL



CHINA WHITE



CLARET



COCOA

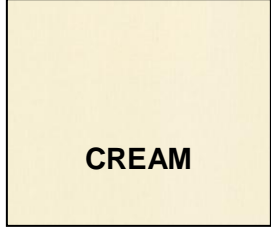

CREAM

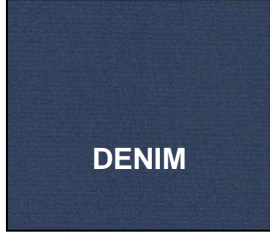

DENIM

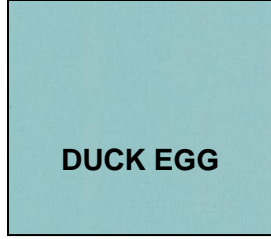

DUCK EGG

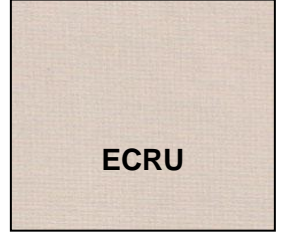

ECRU

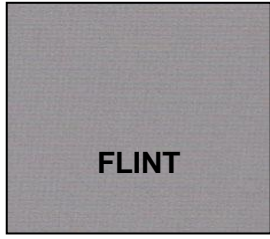

FLINT

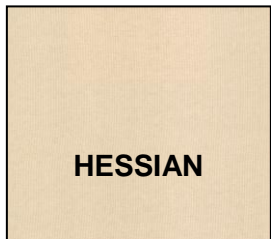

HESSIAN



HOT PINNK

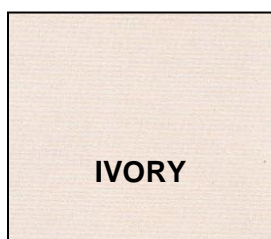

IVORY



LAUREL

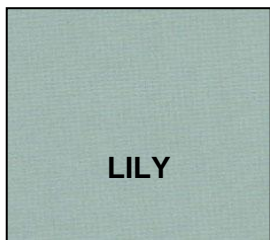

LILY



MARASCHINO

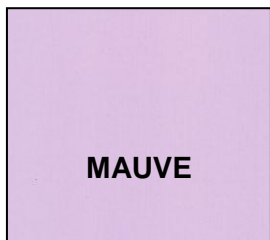

MAUVE

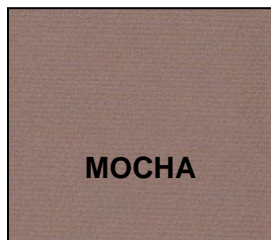

MOCHA

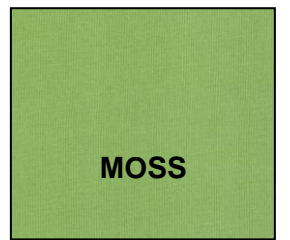

MOSS

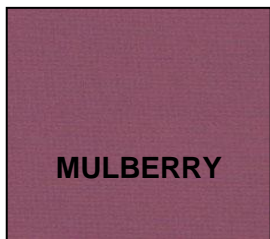

MULBERRY

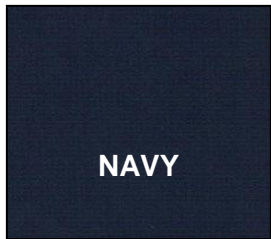

NAVY

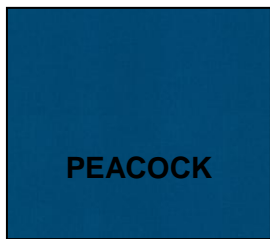

PEACOCK

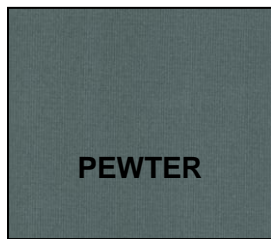

PEWTER



PURPLE

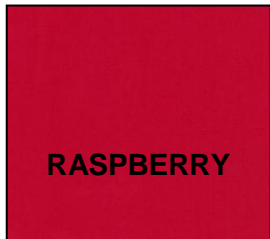

RASPBERRY

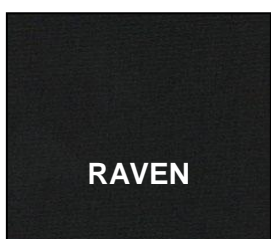

RAVEN

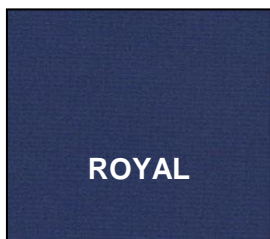

ROYAL

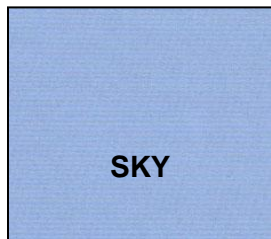

SKY



SLATE

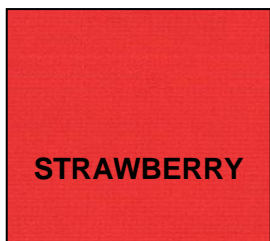

STRAWBERRY



SUNFLOWER



TEAL

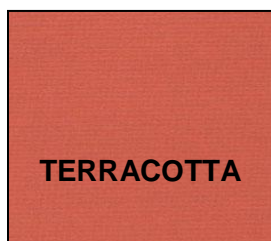

TERRACOTTA



TRUFFLE

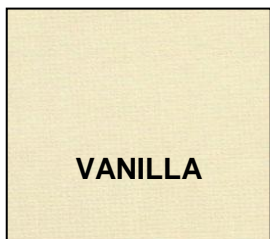

VANILLA



Colours only as good as the quality of print
Please ask for actual fabric samples

Roller Blind Specification

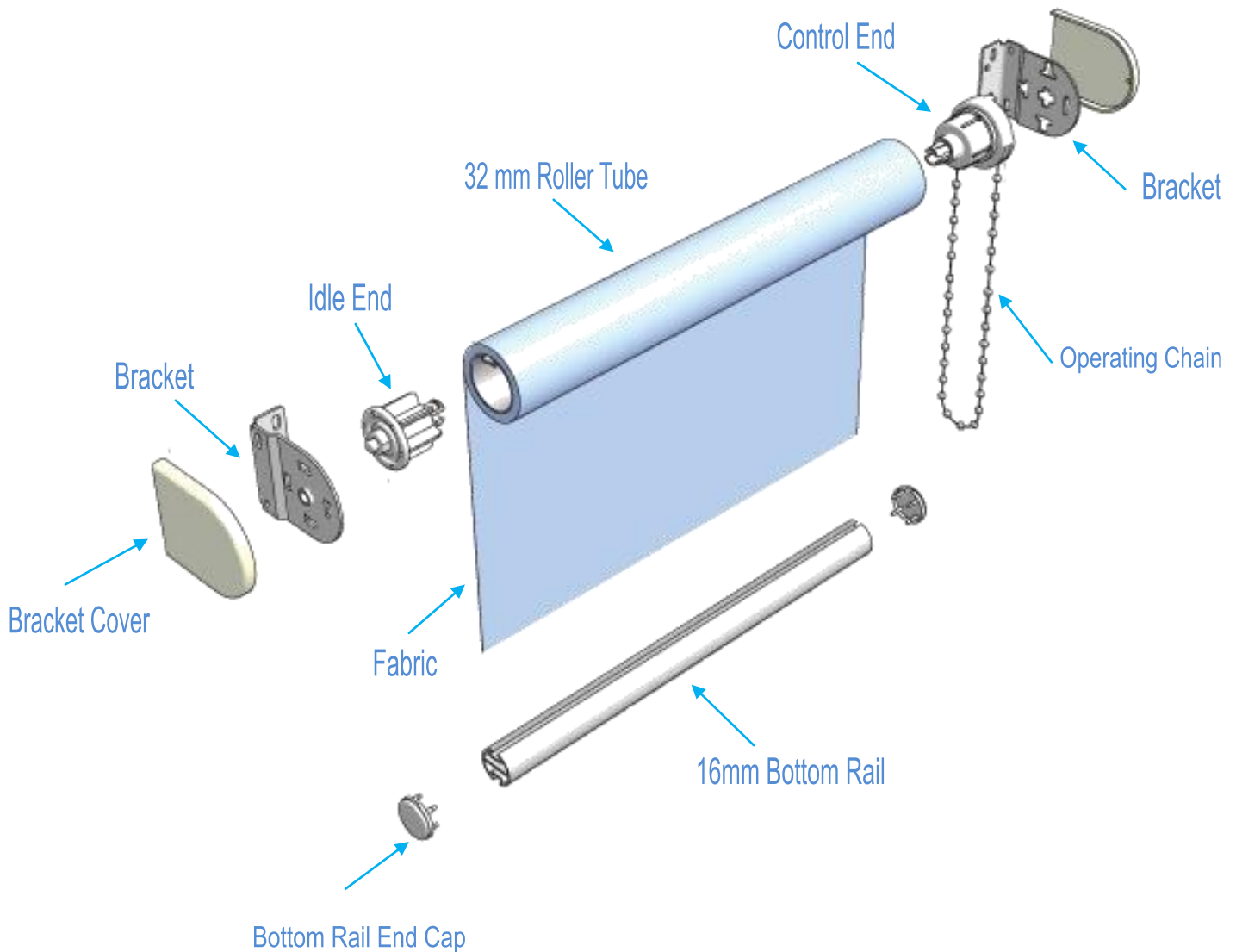

**CONTACT US TODAY
FOR A FREE SITE SURVEY & QUOTATION**

0800 3 10 10 20